

LB *Quad*™ RGBA



WIRELESS DMX
WICICLE®
ENABLED



Blizzard Lighting, LLC
www.blizzardlighting.com
Waukesha, WI USA
Copyright (c) 2017

TABLE OF CONTENTS

LB-Par™ RGBA	1
1. Getting Started	3
What's In The Box?	3
Getting It Out Of The Box	3
Powering Up!	3
Getting A Hold Of Us	3
Safety Instructions (Don't Stick Your Hand In The Toaster!)	4
2. Meet The LB-Par™ RGBA	3
Features	5
DMX Quick Reference	5
The LB-Par™ RGBA Pin-up Picture	6
3. Setup	7
Fuse Replacement	7
Connecting A Bunch Of LB-Par™ RGBA Fixtures	7
Data/DMX Cables	7
Cable Connectors	8
3-Pin??? 5-Pin??? Huh?	8
Take It To The Next Level: Setting up DMX Control	8
Fixture Linking (Master/Slave Mode)	9
Mounting/Rigging	9
Using this fixture with the wiCICLE® Wireless DMX System	10
4. Operating Adjustments	12
Navigating The Control Panel	12
Control Panel Menu Structure	13
DMX Mode	13
Master/Slave Mode	13
Built-in Programs & Speed Control	13
Static Colors, Strobe, & Sound Active Mode	13
Manual Color Mixing	13
LED Display On/Off	14
Dimming Curve & Speed Settings	14
DMX Channel Values In-Depth	14
5. Appendix	15
Keeping Your LB-Par™ RGBA As Good As New	16
Returns (Gasp!)	16
Shipping Issues	16
Tech Specs	17
Troubleshooting	17
Dimensional Drawings	18
Internal/External Parts	19

1. GETTING STARTED

What's In The Box?

- 1 x LB-Par™ RGBA Professional LED Fixture
- An Ever-So-Handy Power Cord
- This Lovely User Manual

Getting It Out Of The Box

Congratulations on your purchase of one super-cool 4-in-1 LED PAR can! Now that you've got your LB-Par™ RGBA (or hopefully, more!), you should carefully unpack the box and check the contents to ensure that all parts are present and in good condition. If anything looks as if it has been damaged in transit, notify the shipper immediately and keep the packing material for inspection. Again, please save the carton and all packing materials. If a fixture must be returned to the factory, it is important that the fixture be returned in the original factory box and packing.

Powering Up!

All fixtures must be powered directly off a switched circuit and **cannot be run off a rheostat (variable resistor) or dimmer circuit, even if the rheostat or dimmer channel is used solely for a 0% to 100% switch.**

AC Voltage Switch - Not all fixtures have a voltage select switch, so please verify that the fixture you receive is suitable for your local power supply. See the label on the fixture or refer to the fixture's specifications chart for more information. A fixture's listed current rating is its average current draw under normal conditions. Check the fixture or device carefully to make sure that if a voltage selection switch exists that it is set to the correct line voltage you will use.

Warning! Verify that the voltage select switch on your unit matches the line voltage applied. Damage to your fixture may result if the line voltage applied does not match the voltage indicated on the voltage selector switch. All fixtures must be connected to circuits with a suitable Ground (Earthing).

Getting A Hold Of Us

If something is wrong, please just visit our website at www.blizzardlighting.com and open a support ticket. We'll be happy to help, honest.

Disclaimer: The information and specifications contained in this document are subject to change without notice. Blizzard Lighting™ assumes no responsibility or liability for any errors or omissions that may appear in this user manual. Blizzard Lighting™ reserves the right to update the existing document or to create a new document to correct any errors or omissions at any time. You can download the latest version of this document from www.blizzardlighting.com.

Author:	Date:	Last Edited:	Date:
J. Thomas	1/30/2015	J. Thomas	2/8/2017

SAFETY INSTRUCTIONS



Please read these instructions carefully. They include important information about the installation, usage and maintenance of this product.

- Please keep this User Guide for future use. If you sell the unit to someone else, be sure that they also receive this User Guide.
- ALWAYS make sure that you are connecting to the proper voltage, and that the line voltage you are connecting to is not higher than that stated on the decal or rear panel of the fixture.
- This product is intended for indoor use only.
- To prevent risk of fire or shock, do not expose fixture to rain or moisture.
- Make sure there are no flammable materials close to the unit while operating.
- The unit must be installed in a location with adequate ventilation, at least 20in (50cm) from adjacent surfaces. Be sure that no ventilation slots are blocked.
- ALWAYS disconnect from the power source before servicing or replacing fuse and be sure to replace with same fuse size and type.
- ALWAYS secure fixture using a safety chain. NEVER carry the fixture by its cord. Use its carrying handles.
- DO NOT operate at ambient temperatures higher than 104°F (40°C).
- In the event of a serious operating problem, stop using the unit immediately. NEVER try to repair the unit by yourself. Repairs carried out by unskilled people can lead to damage or malfunction. Please contact the nearest authorized technical assistance center. Always use the same type spare parts.
- NEVER connect the device to a dimmer pack.
- Make sure the power cord is never crimped or damaged.
- Never disconnect the power cord by pulling or tugging on the cord.
- Avoid direct eye exposure to the light source while it is on.

Caution! There are no user serviceable parts inside the unit. Do not open the housing or attempt any repairs yourself. In the unlikely event your unit may require service, please contact Blizzard Lighting online at www.blizzardlighting.com/support.

2. MEET THE LB-PAR RGBA

MAIN FEATURES

- 12* high output 10-watt 4-in-1 RGBA LEDs
- User selectable 4/9 DMX channels
- Full color mixing in standalone, master/slave and DMX modes
- Built-in automated programs via master/slave
- Built-in sound activated programs via master/slave
- Easy to use LED digital control panel
- User selectable 8/32-bit dimming curve modes
- 3-pin male input and 3-pin female output
- Dual mounting yoke allows flexibility in positioning
- Durable, scratch resistant composite housing

ADDITIONAL FEATURES

- Lightweight and compact (It kept its New Years' resolution!)
- 4-button LED control panel for easy programming
- Dual bracket for flexibility in mounting
- Flicker-free constant-current LED driver
- 3-pin male input and 3-pin female output
- PowerCon™ compatible AC power In/Out connectors
- Can directly power the wiCICLE® wireless system via DMX

DMX Quick Reference (9-Channel Mode)

Channel	What It Does
1	Dimmer (0% <-> 100%)
2	Red Intensity (0% <-> 100%)
3	Green Intensity (0% <-> 100%)
4	Blue Intensity (0% <-> 100%)
5	Amber Intensity (0% <-> 100%)
6	Strobe (slow <-> fast)
7	Built-In Programs
8	Speed (slow <-> fast)
9	32-bit Dimming

DMX Quick Reference (4-Channel Mode)

Channel	What It Does
1	Red Intensity (0% <-> 100%)
2	Green Intensity (0% <-> 100%)
3	Blue Intensity (0% <-> 100%)
4	Amber Intensity (0% <-> 100%)

Figure 1: The LB-Par™ RGBA Pin-Up Picture



Figure 2: The Rear Connections



3. SETUP



Before replacing a fuse, disconnect power cord. ALWAYS replace with the same type and rating of fuse.

Fuse Replacement

CAUTION! The LB-Par™ RGBA utilizes a high-output switch-mode power supply with an internal fuse. Under normal operating conditions, the fuse should not require replacement. The fuse is field replaceable, however it is an advanced procedure suited to qualified individuals. Should your LB-Par™ RGBA fuse require replacement, please contact Blizzard Lighting for instructions, or to return your unit for service.

Connecting A Bunch of LB-Par™ RGBA Fixtures

You will need a serial data link to run light shows using a DMX-512 controller or to run shows on two or more fixtures set to sync in master/slave operating mode. The combined number of channels required by all the fixtures on a serial data link determines the number of fixtures the data link can support.

Fixtures on a serial data link must be daisy chained in one single line. Also, connecting more than 32 fixtures on one serial data link without the use of a DMX optically-isolated splitter may result in deterioration of the digital DMX signal. The maximum recommended cable-run distance is 500 meters (1640 ft). The maximum recommended number of fixtures on a serial data link is 32 fixtures.

Data/DMX Cabling

To link fixtures together you'll need data cables. You should use data-grade cables that can carry a high quality signal and are less prone to electromagnetic interference.

For instance, Belden© 9841 meets the specifications for EIA RS-485 applications. Standard microphone cables will "probably" be OK, but note that they cannot transmit DMX data as reliably over long distances. In any event, the cable should have the following characteristics:

2-conductor twisted pair plus a shield

Maximum capacitance between conductors – 30 pF/ft.

Maximum capacitance between conductor & shield – 55 pF/ft.

Maximum resistance of 20 ohms / 1000 ft.

Nominal impedance 100 – 140 ohms

Cable Connectors

Cables must have a male XLR connector on one end and a female XLR connector on the other end. (Duh!)

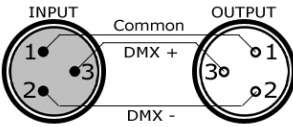

A Word on Termination: DMX is a resilient communication protocol, however errors still occasionally occur. Termination reduces signal errors, and therefore best practices include use of a terminator in all circumstances. If you are experiencing problems with erratic fixture behavior, especially over long signal cable runs, a terminator may help improve performance.

To build your own DMX Terminator:
Obtain a 120-ohm, 1/4-watt resistor, and wire it between pins 2 & 3 of the last fixture. They are also readily available from specialty retailers.

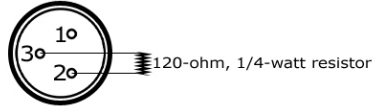

CAUTION: Do not allow contact between the common and the fixture's chassis ground. Grounding the common can cause a ground loop, and your fixture may perform erratically. Test cables with an ohm meter to verify correct polarity and to make sure the pins are not grounded or shorted to the shield or each other.

3-Pin??? 5-Pin??? Huh?!?

If you use a controller with a 5 pin DMX output connector, you will need to use a 5 pin to 3 pin adapter. They are widely available over the internet and from specialty retailers. If you'd like to build your own, the chart below details a proper cable conversion:

Conductor	3-Pin Female (Output)	5-Pin Male (Input)
Ground/Shield	Pin 1	Pin 1
DMX Data (-)	Pin 2	Pin 2
DMX Data (+)	Pin 3	Pin 3
Not Used.	No Connection.	No Connection.
Not Used.	No Connection.	No Connection.

Take It To The Next Level: Setting Up DMX Control

Step 1: Connect the male connector of the DMX cable to the female connector (output) on the controller.



Step 2: Connect the female connector of the DMX cable to the first fixture's male connector (input). *Note:* It doesn't matter which fixture address is the first one connected. We recommend connecting the fixtures in terms of their proximity to the controller, rather than connecting the lowest fixture number first, and so on.

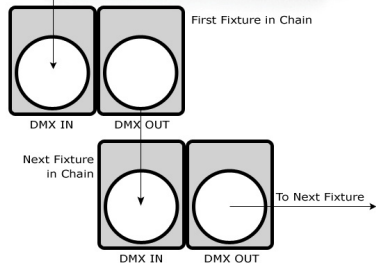

Step 3: Connect other fixtures in the chain from output to input as above. Place a DMX terminator on the output of the final fixture to ensure best communication.

Fixture Linking (Master/Slave Mode)

1. Connect the (male) 3 pin connector side of the DMX cable to the output (female) 3 pin connector of the first fixture.
2. Connect the end of the cable coming from the first fixture which will have a (female) 3 pin connector to the input connector of the next fixture consisting of a (male) 3 pin connector. Then, proceed to connect from the output as stated above to the input of the following fixture and so on.

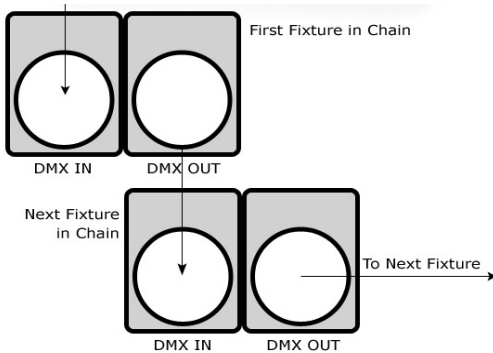

A quick note: Often, the setup for Master-Slave and Standalone operation requires that the first fixture in the chain be initialized for this purpose via either settings in the control panel or DIP-switches. Secondly, the fixtures that follow may also require a slave setting.

Check the **“Operating Adjustments”** section in this manual for complete instructions for this type of setup and configuration.

Mounting & Rigging

This fixture may be mounted in any SAFE position provided there is enough room for ventilation.

It is important never to obstruct the fan or vents pathway. Mount the fixture using a suitable “C” or “O” type clamp. The clamp should be rated to hold at least 10x the fixture’s weight to ensure structural stability. Do not mount to surfaces with unknown strength, and ensure properly “rated” rigging is used when mounting fixtures overhead.

Adjust the angle of the fixture by loosening both knobs and tilting the fixture. After finding the desired position, retighten both knobs.

- When selecting installation location, take into consideration lamp replacement access (if applicable) and routine maintenance.
- Safety cables **MUST ALWAYS** be used.
- Never mount in places where the fixture will be exposed to rain, high humidity, extreme temperature changes or restricted ventilation.

USING THIS FIXTURE WITH THE wiCICLE® WIRELESS DMX SYSTEM

In addition to the unbridled thrill you already received the first time you plugged in your fixture, you'll be delighted to know that This fixture also works seamlessly with our wiCICLE® Wireless DMX system, **without additional power.**

- ONLY fixtures bearing this logo are certified for use with the wiCICLE® without external power.

- **Unauthorized modification and/or using the wiCICLE® with unapproved fixtures may cause damage to the wiCICLE® or fixture. UNDER NO CIRCUMSTANCES IS BLIZZARD LIGHTING RESPONSIBLE FOR ANY DAMAGE FROM SUCH OPERATION.**



- Fixtures bearing the above logo **MUST** only use cable and connectors which separate chassis/case ground from cable shielding. Cabling with the shield connected to the connector's case/chassis may cause malfunction and damage to the wiCICLE® or fixture.

- wiCICLE® transmitters have additional power requirements and therefore cannot be powered directly from the fixture. You will need to utilize the supplied AC/DC adaptor to drive wiCICLE® transmitters in your system.

Each wiCICLE® acts as both a transmitter and a receiver, depending on whether a DMX source is applied to the integral XLR connector. This is an extremely powerful feature of the system, however, it also requires 1 piece of due diligence, and that is the removal of extraneous DMX signals from your lighting rig BEFORE proceeding.

SO: BEFORE DOING ANYTHING ELSE, YOU SHOULD DISABLE ANY BUILT-IN PROGRAMS IN THE FIXTURES YOU WISH TO CONNECT AND/OR SET THEM AS SLAVES PRIOR TO RETURNING THEM TO DMX MODE (IF APPLICABLE). Most fixtures contain a built-in automatic, sound active or custom program which is designed to operate with the fixture NOT connected to a DMX chain.

Some of these programs will automatically run unless the fixture is set to slave mode. These fixtures typically sense DMX automatically and switch to DMX mode upon receiving DMX signal (our Pucks do that!)

If you plug a wiCICLE® "receiver" into an autosensing fixture set as a "master," chances are good that the wiCICLE® "receiver" will begin transmitting the master program. Most times, this is undesirable, and taking the two seconds to switch these programs off will solve a lot of ails.

Got that done? Good! Then let's proceed!

1. Plug the wiCICLE® Receiver into the "DMX IN" connector of the fixture and verify it is receiving power (the **STATUS LED** should illuminate.)
2. Connect the AC/DC adaptor to the wiCICLE® Transmitter and verify it is receiving power (the **STATUS LED** should illuminate.)
3. Press the **RECESSED SELECTOR BUTTON** on the Transmitter to select the operating channel group. (The system will store this setting for future use)

The 7-Color Status LED will change color to indicate the current channel group:

- GROUP 1: **RED**
- GROUP 2: **GREEN**
- GROUP 3: **YELLOW**
- GROUP 4: **BLUE**
- GROUP 5: **VIOLET**
- GROUP 6: **CYAN**
- GROUP 7: **WHITE**

NOTE: "GROUP" number also corresponds to the "GROUP" setting on our LightCaster™ wireless DMX Transceiver.

4. Follow the same procedure on the Receiver to select the channel group.
5. Once both the transmitter and receiver(s) are both set to the same channel group, connect the transmitter to the DMX controller or the DMX out of a fixture on your DMX chain.
6. Once a DMX signal is provided to the transmitter, the status LED will blink **RED** slowly until communication is established with the receiver. The status LED on the receiver(s) will flash **GREEN** slowly until communication is established.
7. Once the clearest channel is auto-selected, the status LEDs will blink quickly on both the transmitter and receiver. NOTE: The color of the LED DURING operation does not indicate channel group, instead it indicates whether the unit is transmitting or receiving. **That's It!**

4. OPERATING ADJUSTMENTS

The Control Panel

All the goodies and different modes possible with the LB-Par™ RGBA are accessed by using the control panel on the rear of the fixture. There are 4 control buttons below the LED display which allow you to navigate through the various control panel menus.

<MENU>

Is used to navigate to the previous higher-level menu item.

<ENTER>

Is used to select and confirm/store the current selection.

<UP>

Scrolls through menu items and numbers in ascending order.

<DOWN>

Scrolls through menu items and numbers in descending order.

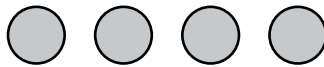

MENU ENTER UP DOWN

The control panel LED display shows the menu items you select from the menu map on page #12. When a menu function is selected, the display will show immediately the first available option for the selected menu function. To select a menu item, press **<ENTER>**.

Use the **<UP>** and **<DOWN>** buttons to navigate the menu options. Press the **<ENTER>** button to select the menu function currently displayed, or to enable a menu option. To return to the previous option or menu without changing the value, press the **<MENU>** button.

Control Panel Menu Structure

Addr	1-512	To choose the DMX address
CHNL	CH-1	4-channel DMX mode
	CH-2	9-channel DMX mode
SP--	0-99	Speed adjustments (0-99)
Pr--	1-13	Built-in programs (1-13)
SOUN	<ENTER>	Sound active mode
CoLo	1-15	Built-in colors (15 = off)
Strb	0-20	Flash / strobe speed
rL--	000 - 255	Red intensity (0% <--> 100%)
GL--	000 - 255	Green intensity (0% <--> 100%)
bL--	000 - 255	Blue intensity (0% <--> 100%)
AL--	000 - 255	Amber intensity (0% <--> 100%)
LEd	on-off	Display menu on/off
nodE	0-4	Dimming speed (fast <-->slow)
TEnP	<ENTER>	Check LED board temperature
UErn	<ENTER>	Software version
rSEt	yes-no	Restore factory settings

DMX Mode

Allows the unit to be controlled by any universal DMX controller.

Set the Starting DMX Address:

The default mode for the fixture is DMX, so the first menu item that you can edit is the starting DMX address.

- 1.) Navigate the main menu until you reach **Addr**, and press **<ENTER>**.
- 2.) Use the **<UP/DOWN>** buttons to select a DMX channel from **001-512**.
- 3.) Press the **<ENTER>** button to confirm.

Select the DMX Channel Mode:

- 1.) Navigate the main menu until you reach **CHNL**, and press **<ENTER>**.
- 2.) Use the **<UP/DOWN>** buttons to select either **1-CH (4-ch)** or **2-CH (9-ch)** mode.
- 3.) Press the **<ENTER>** button to confirm.

Slave Mode: Set slave fixtures to DMX mode. They will automatically follow the master fixture (first fixture in the DMX chain).

Built-in Programs & Speed Control

- 1.) Navigate the main menu until you reach **Pr--**, and press **<ENTER>**.
- 2.) Use the **<UP/DOWN>** buttons to choose any of its built-in programs from **1-13**.
- 3.) Press the **<ENTER>** button to confirm your choice.
- 4.) You can then adjust the speed of the program.

Speed:

- a.) Navigate the main menu until you reach **SP--**, and press **<ENTER>**.
- b.) Then use the **<UP/DOWN>** buttons to select a speed setting from **0-99**.
- c.) Press the **<ENTER>** button to confirm.

Static Colors, Strobe, & Sound Active Mode

- 1.) Navigate the main menu until you reach **CoLo**, and press **<ENTER>**.
- 2.) Use the **<UP/DOWN>** buttons to select any of its static colors from **1-15** (15=off).
- 3.) Press the **<ENTER>** button to confirm your choice.
- 4.) You can then add a strobe effect if desired.

Strobe:

- a.) Navigate the main menu until you reach **Strb**, and press **<ENTER>**.
- b.) Then use the **<UP/DOWN>** buttons to select a strobe speed setting from **0-20** (fast <--> slow).
- c.) Press the **<ENTER>** button to confirm.

Sound Active Mode: Navigate the main menu until you reach **SOUN**, and press **<ENTER>**.

Manual Color Mixing:

Mix your own custom colors using the R/G/B/A intensity level setting.

Red:

- 1.) Navigate the main menu until you reach **rL--**, and press **<ENTER>**.
- 2.) Use the **<UP/DOWN>** buttons to adjust red **000-255**. (0% <--> 100%).
- 3.) Press the **<ENTER>** button to confirm.

Green:

- 1.) Navigate the main menu until you reach **gL--**, and press **<ENTER>**.
- 2.) Use the **<UP/DOWN>** buttons to adjust green **000-255**. (0% <--> 100%).
- 3.) Press the **<ENTER>** button to confirm.

Blue:

- 1.) Navigate the main menu until you reach **bL--**, and press **<ENTER>**.
- 2.) Use the **<UP/DOWN>** buttons to adjust blue **000-255**. (0% <--> 100%).
- 3.) Press the **<ENTER>** button to confirm.

Amber:

- 1.) Navigate the main menu until you reach **aL--**, and press **<ENTER>**.
- 2.) Use the **<UP/DOWN>** buttons to adjust amber **000-255**. (0% <--> 100%).
- 3.) Press the **<ENTER>** button to confirm.

LED Display On/Off:

You can set the LED menu display to either stay on continually, or turn off after 30 seconds of inactivity.

- 1.) Navigate the main menu until you reach **LEd**, and press **<ENTER>**.
- 2.) Use the **<UP/DOWN>** buttons to highlight either **on** or **oFF**.
- 3.) The **On** setting will keep the display on continually, and **oFF** will turn the display off after 30s.
- 4.) Press the **<ENTER>** button to confirm your choice.

Dimming Speed & Curve Settings:

You can manually set the fixtures dimming curve of your choice:

- 1.) Navigate the main menu until you reach **nodE**, and press **<ENTER>**.
- 2.) Use the **<UP/DOWN>** buttons to highlight a speed from **0-4** (fast <--> slow).
- 3.) Press the **<ENTER>** button to confirm.

DMX Values In-Depth (4-Channel Mode)

Channel	Value	What It Does
1	000 <--> 255	Red Intensity (0% <--> 100%)
2	000 <--> 255	Green Intensity (0% <--> 100%)
3	000 <--> 255	Blue Intensity (0% <--> 100%)
4	000 <--> 255	Amber Intensity (0% <--> 100%)

DMX Values In-Depth (9-Channel Mode)

Channel	Value	What It Does
1	000 <--> 255	Dimmer (0% <--> 100%)
2	000 <--> 255	Red Intensity (0% <--> 100%)
3	000 <--> 255	Green Intensity (0% <--> 100%)
4	000 <--> 255	Blue Intensity (0% <--> 100%)
5	000 <--> 255	Amber Intensity (0% <--> 100%)
6	000 <--> 255	Strobe Strobe (Slow <--> Fast)
7	000 <--> 009 010 <--> 019 020 <--> 029 030 <--> 039 040 <--> 049 050 <--> 059 060 <--> 069 070 <--> 079 080 <--> 089 090 <--> 099 100 <--> 109 110 <--> 119 120 <--> 129 130 <--> 139 140 <--> 255	Programs, Auto, and Sound Active Dimmer Speed Program 1 (R/G/B jump) Program 2 (R/G/B fade-in/out) Program 3 (R/G/B fade) Program 4 (R/G/B/A jump) Program 5 (R/G/B/A fade-in/out) Program 6 (R/G/B/A fade) Program 7 (7-Color jump) Program 8 (7-color fade-in/out) Program 9 (7-color fade) Program 10 (Multicolor Jump) Program 11 (Multicolor fade-in/out) Program 12 (Multicolor fade) Auto Mode (Loop all programs) Sound Active Mode
8	000 <--> 255	Auto Program Speed Fade Speed (Slow <--> Fast)
9	000 <--> 005 006 <--> 055 056 <--> 105 106 <--> 155 156 <--> 205 206 <--> 255	32-Bit Dimmer As set in the control menu display Mode 0 = 8-bit, 256 dimming steps Mode 1 = 32-bit, 0-25% intensity range Mode 2 = 32-bit, 0-50% intensity range Mode 3 = 32-bit, 0-75% intensity range Mode 4 = 32-bit, full intensity dimming

5. APPENDIX

A Quick Lesson On DMX

DMX (aka DMX-512) was created in 1986 by the United States Institute for Theatre Technology (USITT) as a standardized method for connecting lighting consoles to lighting dimmer modules. It was revised in 1990 and again in 2000 to allow more flexibility. The Entertainment Services and Technology Association (ESTA) has since assumed control over the DMX512 standard. It has also been approved and recognized for ANSI standard classification.

DMX covers (and is an abbreviation for) Digital MultipleXed signals. It is the most common communications standard used by lighting and related stage equipment.

DMX provides up to 512 control "channels" per data link. Each of these channels was originally intended to control lamp dimmer levels. You can think of it as 512 faders on a lighting console, connected to 512 light bulbs. Each slider's position is sent over the data link as an 8-bit number having a value between 0 and 255. The value 0 corresponds to the light bulb being completely off while 255 corresponds to the light bulb being fully on.

DMX data is transmitted at 250,000 bits per second using the RS-485 transmission standard over two wires. As with microphone cables, a grounded cable shield is used to prevent interference with other signals.

There are five pins on a DMX connector: a wire for ground (cable shield), two wires for "Primary" communication which goes from a DMX source to a DMX receiver, and two wires for a "Secondary" communication which goes from a DMX receiver back to a DMX source. Generally, the "Secondary" channel is not used so data flows only from sources to receivers. Hence, most of us are most familiar with DMX-512 as being employer over typical 3-pin "mic cables," although this does not conform to the defined standard.

DMX is connected using a daisy-chain configuration where the source connects to the input of the first device, the output of the first device connects to the input of the next device, and so on. The standard allows for up to 32 devices on a single DMX link.

Each receiving device typically has a means for setting the "starting channel number" that it will respond to. For example, if two 6-channel fixtures are used, the first fixture might be set to start at channel 1 so it would respond to DMX channels 1 through 6, and the next fixture would be set to start at channel 7 so it would respond to channels 7 through 12.

The greatest strength of the DMX communications protocol is that it is very simple and robust. It involves transmitting a reset condition (indicating the start of a new "packet"), a start code, and up to 512 bytes of data. Data packets are transmitted continuously. As soon as one packet is finished, another can begin with no delay if desired (usually another follows within 1 ms). If nothing is changing (i.e. no lamp levels change) the same data will be sent out over and over again. This is a great feature of DMX -- if for some reason the data is not interpreted the first time around, it will be re-sent shortly.

Not all 512 channels need to be output per packet, and in fact, it is very uncommon to find all 512 used. The fewer channels are used, the higher the "refresh" rate. It is possible to get DMX refreshes at around 1000 times per second if only 24 channels are being transmitted. If all 512 channels are being transmitted, the refresh rate is around 44 times per second.

In summary, since its design and evolution in the 1980's DMX has become the standard for lighting control. It is flexible, robust, and scalable, and its ability to control everything from dimmer packs to moving lights to foggers to lasers makes it an indispensable tool for any lighting designer or lighting performer.

Keeping Your LB-Par™ RGBA As Good As New

The fixture you've received is a rugged, tough piece of pro lighting equipment, and as long as you take care of it, it will take care of you. That said, like anything, you'll need to take care of it if you want it to operate as designed. You should absolutely keep the fixture clean, especially if you are using it in an environment with a lot of dust, fog, haze, wild animals, wild teenagers or spilled drinks.

Cleaning the optics routinely with a suitable glass cleaner will greatly improve the quality of light output. Keeping the fans free of dust and debris will keep the fixture running cool and prevent damage from overheating.

In transit, keep the fixtures in cases. You wouldn't throw a prized guitar, drumset, or other piece of expensive gear into a gear trailer without a case, and similarly, you shouldn't even think about doing it with your shiny new light fixtures.

Common sense and taking care of your fixtures will be the single biggest thing you can do to keep them running at peak performance and let you worry about designing a great light show, putting on a great concert, or maximizing your client's satisfaction and "wow factor." That's what it's all about, after all!

Returns (Gasp!)

We've taken a lot of precautions to make sure you never even have to worry about sending a defective unit back, or sending a unit in for service. But, like any complex piece of equipment designed and built by humans, once in a while, something doesn't go as planned. If you find yourself with a fixture that isn't behaving like a good little fixture should, you'll need to obtain a Return Authorization (RA).

Don't worry, this is easy. Just go to our website and open a support ticket at www.blizzardlighting.com/support, and we'll issue you an RA. Then, you'll need to send the unit to us using a trackable, pre-paid freight method. We suggest using USPS Priority or UPS. Make sure you carefully pack the fixture for transit, and whenever possible, use the original box & packing for shipping.

When returning your fixture for service, be sure to include the following:

- 1.) Your contact information (Name, Address, Phone Number, Email address).
- 2.) The RA# issued to you
- 3.) A brief description of the problem/symptoms.

We will, at our discretion, repair or replace the fixture. Please remember that any shipping damage which occurs in transit to us is the customer's responsibility, so pack it well!

Shipping Issues

Damage incurred in shipping is the responsibility of the shipper, and must be reported to the carrier immediately upon receipt of the items. Claims must be made within seven (7) days of receipt.

Tech Specs!

Weight & Dimensions						
Width	11.2 in (284 mm)					
Depth	4.5 inches (115.6 mm)					
Height	10.6 inches (269.5 cm)					
Weight	5 lbs (2.3 kg)					
Power						
Operating Voltage	100-240VAC, 50-60 Hertz					
Power Consumption	77W, .65A, PF: .99					
Light Source						
LED	12* 10-watt 4-in-1 RGBA LEDs					
Optical						
Beam Angle	25 degree beam					
Luminous Intensity	Lux/m	Red	Green	Blue	Amber	All
	1m	5,180	4,290	5,640	3,540	17,000
	2m	1,660	1,300	1,750	1,130	5,260
Thermal						
Max. Operating Temp.	104 degrees F (40 degrees C) ambient					
Control						
Protocol	USITT DMX-512					
DMX Channels	4/9-channel					
Input/Output	3-pin XLR Male/Female					
Other Operating Modes	Standalone, Master/Slave, Sound Active, Color Preset					
Other Information						
There should be an award for anyone who actually finishes a tube of chapstick.						
Warranty	2-year limited warranty, does not cover malfunction caused by damage to LEDs.					

Troubleshooting

Symptom	Solution
Fixture Auto-Shut Off	Check the fan in the fixture. If it is stopped or moving slower than normal, the unit may have shut itself off due to high heat. This is to protect the fixture from overheating.
Beam is Dim	Check optical system and clean excess dust/grime.
No Light Output	Check to ensure fixture is operating under correct mode, IE sound active/auto/DMX/Etc., if applicable.
Chase Speed Too Fast/Slow	Check to ensure proper setup of speed adjustment.
No Power	Check fuse, AC cord and circuit for malfunction.
Slow Movement	Verify that 220V/110V switch is in the correct position, if applicable. Also check that speed channels are set appropriately.
No Response to Audio	Verify that the fixture is in "Sound Active" mode.

If your problem persists or isn't listed, please open a support ticket online at: www.blizzardlighting.com/support.

Dimensional Drawings

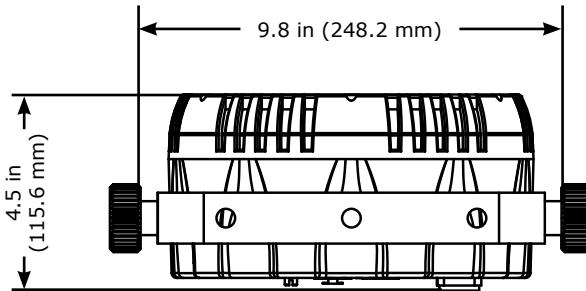
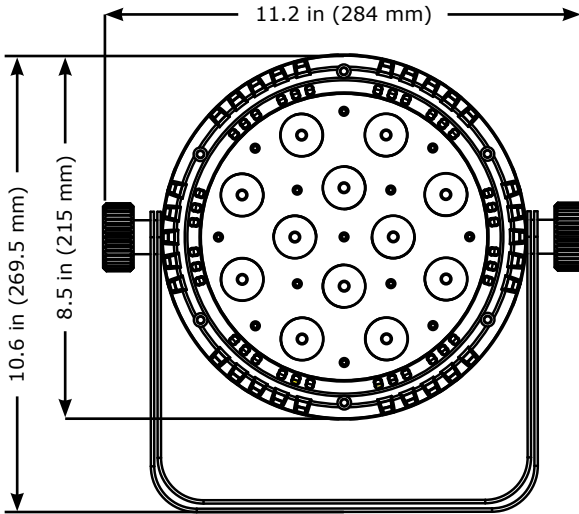

DISCLAIMER:

The power connector fitted to the fixture and fixture cord are designed for compatibility with products manufactured by Neutrik AG, Neutrik USA and their related entities, however they are not manufactured by, affiliated with or endorsed by Neutrik AG, Neutrik USA, or any related entity. Neutrik® and powerCON® are registered trademarks of Neutrik AG.

Internal/External Parts

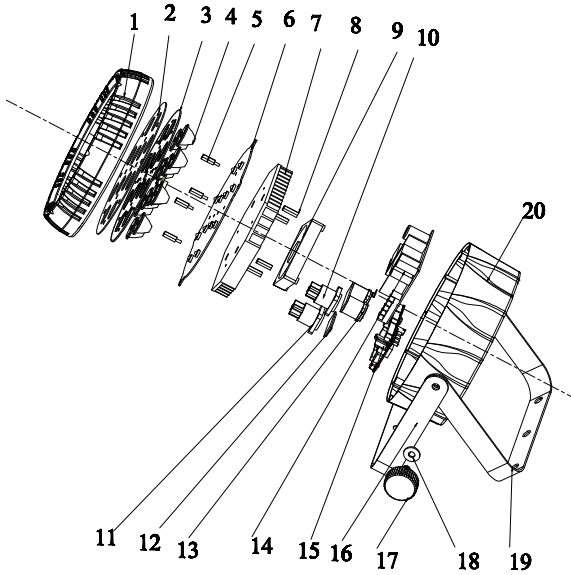

#	Name	#	Name
1.	Upper housing cover	11.	PowerCon™ compatible input
2.	Upper lamp pressing plate	12.	Red PVC
3.	Under lamp pressing plate	13.	PCB-DMX canon socket
4.	Lamps	14.	Power supply
5.	Copper pillar	15.	Master PCB
6.	PCB-lamp board	16.	Outer bracket
7.	Radiator	17.	Knob
8.	Copper pillar	18.	Rubber gasket
9.	8015 fan	19.	Inner bracket
10.	PowerCon™ compatible input	20.	Bottom housing cover



**Enjoy your product!
Our sincerest thanks for your purchase!
--The team @ Blizzard Lighting**