

4

3

2

1

REV		REVISIONS			DATE	APPD
EC #	DESCRIPTION					
00				06/14/2022	SR	

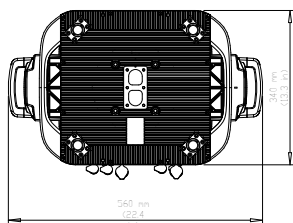
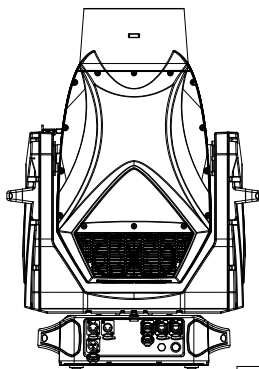
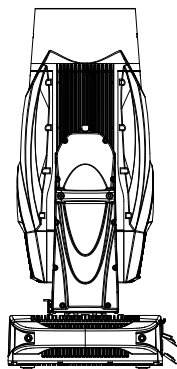
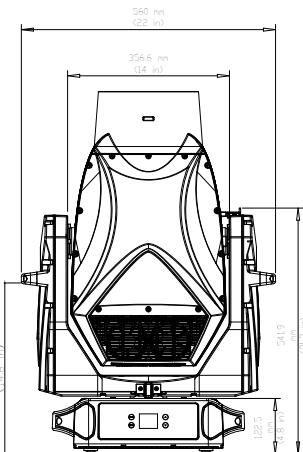
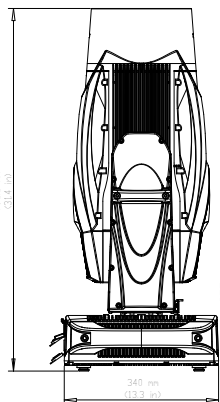
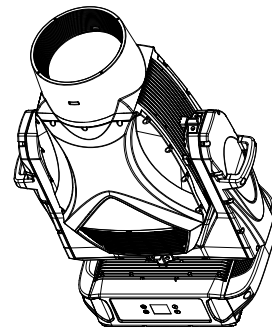
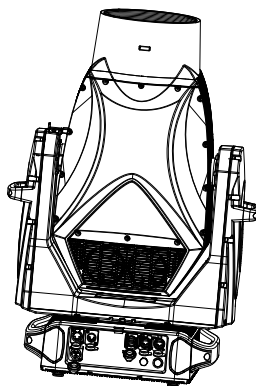
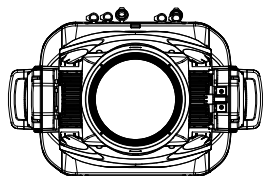

74817-001	VL3600, PROFILE IP, 1000W MONOCHROMATIC LIGHT ENGINE, C/W 2 X VL RAILS AND POWER INPUT CONNECTOR, BLACK
74817-101	VL3600, PROFILE IP, 1000W MONOCHROMATIC LIGHT ENGINE, C/W 2 X VL RAILS AND POWER INPUT CONNECTOR, WHITE
74817-011	VL3600, PROFILE IP, 1000W MONOCHROMATIC LIGHT ENGINE, C/W 2 X VL RAILS AND INSTALLATION, POWER AND DMX 1M TAILS, BLACK
74817-111	VL3600, PROFILE IP, 1000W MONOCHROMATIC LIGHT ENGINE, C/W 2 X VL RAILS AND INSTALLATION, POWER AND DMX 1M TAILS, WHITE

VARI*UTE

NEXT ASSY	TOLERANCE	N/A	DSN BY		Var-Lite, LLC 10911 PETA ST., DALLAS, TX 75238
NOTICE: INFORMATION AND DESIGN DISCLOSED ON THIS DOCUMENT ARE CONSIDERED PROPRIETARY AND SHALL NOT BE REPRODUCED OR DISCLOSED WITHOUT WRITTEN CONSENT. VARILITE, LLC ALL RIGHTS RESERVED.	MATERIAL		OWN BY		VL3600, PROFILE IP, 1000W MONOCHROMATIC LIGHT ENGINE
	FINISH		ALL DIMENSIONS ARE IN INCHES UNLESS NOTED OTHERWISE. REMOVE ALL BURRS AND SHARP EDGES.		SIZE: B REVISION: 00 DRAWING NUMBER:
SCALE: N.T.S.					AUTOCAD LT 2021 SHEET 1 OF 1

4

3

2

1