



VARI***LITE**

VL600 ACCLAIM FRESNEL+

USER MANUAL

INTRODUCTION

OUR GOAL

We are committed to providing you the highest quality in customer service. Our comprehensive resources are available to help your business succeed and ensure you get the full benefit of being a Vari-Lite customer.

TECHNICAL SUPPORT

Our Service and Support team is tasked with online and field support, repair, demo, commissioning, maintenance contracts, and technical training for fixtures and systems. In addition, this team plays a large role in a Systems sales, responsible for administering final commissioning, record-keeping, and organizing services. Refer to the back cover of this User Manual for contacts in your region or visit www.vari-lite.com/support.

CUSTOMER SERVICE

Customer Service is responsible for boxed goods and spare parts quotations, order entry and fulfilment, project delivery, lead times, and general account management. They also manage all after sales warranty fulfilment, RGA, and repairs invoicing in tandem with our After Sales Service & Support team. Visit our website to find a customer service agent in your region.

ADDITIONAL DOCUMENTATION

Additional product documentation, including DMX maps, software, and photometric reports, are available for download on our website.

For more information on installing DMX512 control systems, the following publication is available for purchase from the United States Institute for Theatre Technology (USITT), "Recommended Practice for DMX512: A Guide for Users and Installers, 2nd edition" (ISBN: 9780955703522).

USITT Contact Information:

USITT

315 South Crouse Avenue, Suite 200

Syracuse, New York 13210-1844 USA

Phone: 800-938-7488 or +1-315-463-6463

Fax: 866-398-7488 or +1-315-463-6525

Website: www.usitt.org

ABOUT THIS DOCUMENT

Read all instructions before installing or using this product. Retain this User Manual for future reference.

Additional product information and descriptions may be found on the product data sheet(s) which can be downloaded from the website at www.vari-lite.com.

This User Manual provides necessary information regarding safety, installation, operation and routine maintenance for VL600 Acclaim Fresnel+. Familiarizing yourself with this information will help you to get the most out of your product.



WARNING: It is important to read ALL accompanying safety and installation instructions to avoid damage to the product and potential injury to yourself or others.

SAFETY WARNINGS AND NOTICES

Read this user manual in full before attempting to install, operate or maintain the fixture to which it relates. This user manual is intended to provide general guidance to such suitably qualified personnel. Installation and operation of the fixture are to be performed by qualified personnel only.

When using electrical equipment, basic safety precautions should always be followed including the following:

READ AND FOLLOW ALL SAFETY INSTRUCTIONS.

- For indoor, dry location use only. Do not use outdoors unless fixture is suitably IP rated.
- Use safety tether when mounting.
- Equipment should be mounted in locations and at heights where it will not be readily subjected to tampering by unauthorized personnel.
- Not for residential use. Do not use this equipment for other than intended use.
- Note distance requirement(s) from combustible materials or illuminated objects. Do not mount near gas or electric heaters.
- Install only in locations with adequate ventilation. Ensure sure that ventilation slots are not blocked.
- Ensure that the voltage and frequency of the power supply match the power requirements of the fixture.
- The fixture must be earthed/grounded to the appropriate conductor.
- Do not operate fixture outside the specified ambient temperature range.
- Do not connect the fixture to any dimmer pack.
- The use of accessory equipment not recommended by the manufacturer may cause an unsafe condition and void warranty.
- Refer service to qualified personnel. This fixture contains no user serviceable parts.
- Prior to first use, carefully inspect fixture to ensure no damage has occurred during shipping.
- Materials used in the manufacturing process can cause strong odors when the product is new. These odors dissipate over time.
- Prior to each use, carefully inspect power cables and replace any damaged cables.
- Exterior surfaces of the luminaire will be hot during operation. Take appropriate precautions.
- Continuous use of the fixture may shorten the lifespan. Power down the fixture when not in use.
- Do not cycle power on and off repeatedly. Disconnect mains power if the fixture is not used for an extended period.
- Clean fixtures regularly, particularly when working in a dusty environment.
- Never touch power cables or wires while the fixture is powered on.
- Avoid entangling power wires with other cables.
- In the event of a serious operating problem, immediately discontinue using the fixture.
- It is hazardous to operate luminaires without lens or shield. Shields, lenses, or ultraviolet screens shall be changed if they have become visibly damaged to such an extent that their effectiveness is impaired, for example, by cracks or deep scratches.
- Original packing materials can be reused for transporting the fixture.
- Do not look directly at the LED light beam while the fixture is on.
- This is a Class A product. In a domestic environment this product may cause radio interference, in which case, the user may be required to take adequate measures.
- The light source contained in this luminaire shall only be replaced by the manufacturer or service agent or similarly qualified person.

SAVE THESE INSTRUCTIONS.



WARNING: Refer to National Electrical Code® and local codes for cable specifications. Failure to use proper cable can result in damage to equipment or danger to personnel. Caution Against Direct Sunlight Through Front Lens Assembly



CAUTION! Do not stare into the beam. This fixture is categorized as Risk Group 2 (RG2).

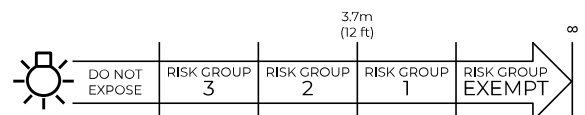

COMPLIANCE NOTICE



FCC DECLARATION OF CONFORMITY

This equipment has been tested and found to comply with the limits for a Class A digital device pursuant to Part 15 of FCC Rules. These limits are designed to provide reasonable protection against harmful interference when this equipment is operated in a commercial environment. This equipment generates, uses, and can radiate radio frequency energy and, if not installed and used in accordance with Vari-Lite system, service, and safety guidelines, may cause harmful interference to radio communications.

As tested under this standard:

FCC 47CFR 15B cIA*CEI

Issued:2009/10/01 Title 47 CFR Part 15 Subpart B Unintentional Radiators Class A

Operation of this equipment in a residential area is likely to cause harmful interference, in which case the user will be required to correct the interference at his/her own expense.



EU DECLARATION OF CONFORMITY

We, Vari-Lite LLC., 10911 Petal Street, Dallas, Texas 75238, declare under our responsibility for the products contained herein are in conformity with the essential requirements of the following European Directives and harmonized standards:

Low Voltage Director (LVD), 2006/95/EC

EN 60589-2-17:1984+A1:1987+A2:1990 used in conjunction with 60598-1:2008/A11:2009

Electromagnetic Compatibility Directive (EMC), 2004//108/EC

EN 55022:2010, EN55024:2010

HOW TO OBTAIN WARRANTY SERVICE

A copy of the Limited Warranty card was included in the shipping package for this product.

To obtain warranty service, please contact customer service at 1-214-647-7880, or entertainment.service@signify.com and request a Return Material Authorization (RMA) for warranty service. You will need to provide the model and serial number of the item being returned, a description of the problem or failure and the name of the registered user or organization. If available, you should have your sales invoice to establish the date of sale as the beginning of the warranty period. Once you obtain the RMA, pack the unit in a secure shipping container or in its original packing box. Be sure to clearly indicate the RMA number on all packing lists, correspondence, and shipping labels. If available, please include a copy of your invoice (as proof of purchase) in the shipping container.

With the RMA number written legibly on or near the shipping address label, return the unit, freight prepaid, to:

Vari-Lite LLC
Attention: Warranty Service (RMA# _____)
10911 Petal Street
Dallas, Texas 75238
USA

As stated in the warranty, it is required that the shipment be insured and FOB our service center.



IMPORTANT! When returning products to Vari-Lite for repairs (warranty or out-of-warranty) from a country other than the USA, “Vari-Lite LLC”, must appear in the address block as the Importer of Record (IOR) on all shipping documentation, Commercial Invoices, etc. This must be done in order to clear customs in a timely manner and prevent returns.

1 DESCRIPTION

FEATURES

- 500 W/650 W-equivalent LED Fresnel – true Fresnel with superior control and light quality than comparable PAR fixtures.
 - Integrated 10° to 50° manual zoom – precise beam sizing with minimal light scatter.
 - Optional rotating 4-leaf barn doors – shape the beam to focus light where you need it.
 - Custom LED light source and RGBL color mixing system – consistent output and color mixing with the entire VL600 Series
 - Available in black or white – the perfect body color for your application.
- For detailed product information, please refer to the Product Guide at <https://www.vari-lite.com/global/products/acclaim-led-fresnel>

Download the product datasheet from the website at www.vari-lite.com for the full technical specifications.

COMPONENTS

The document provides installation and operation instructions for the following products:

- VL600 Acclaim Fresnel+

Read all instructions before installing or using this product. Retain this manual for future reference. Additional product information and descriptions may be found on the product specification sheet.

INCLUDED ITEMS

Each VL600 Acclaim Fresnel+ luminaire includes the following items:

- VL600 Acclaim Fresnel+
- Quick Start Guide

2 INSTALLATION

MOUNTING

The unit should be mounted via its screw holes on the bracket. Always ensure that the unit is firmly fixed to avoid vibration and slipping while operating. Always ensure that the structure to which you are attaching the unit is secure and is able to support a weight of 10 times of the unit's weight. Always use a safety cable that can hold up to 12 times the weight of the unit when installing the fixture. The luminaire must be mounted by professionals.

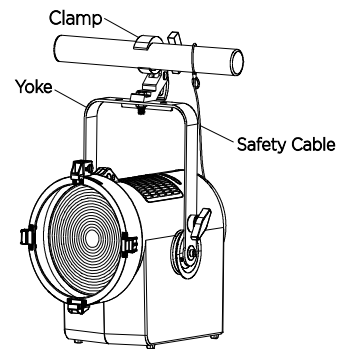

BARNDOOR INSTALLATION

Compatible barndoors are listed in the table below.

VL600 ACCLAIM FRESNEL 4 LEAF BARNDOOR (Black)	912400576893	64511-010
VL600 ACCLAIM FRESNEL 4 LEAF BARNDOOR (White)	912400576894	64511-110

To install barndoor:

- Step 1. Open the activity claw.
- Step 1. Snap the barndoor into the luminaire and close the activity claw as shown.

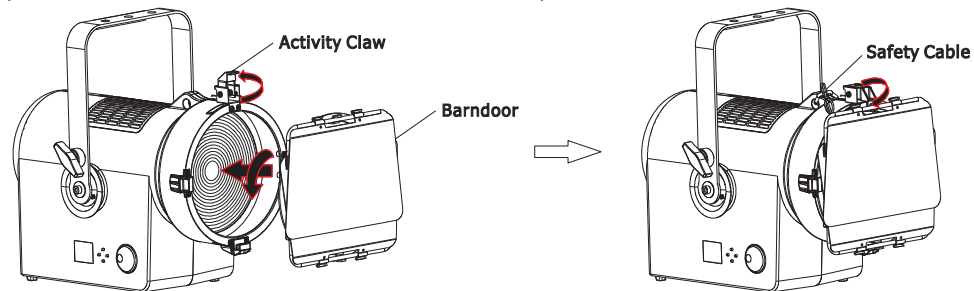

CONNECTING DATA AND POWER

A maximum of 32 luminaires may be connected in any one DMX data link.

A maximum of 4 luminaires may be connected in 120V, 60Hz.

A maximum of 7 luminaires may be connected in 230V, 50Hz.

NOTE: This maximum limit applies to the luminaire “daisy chain” only. Your system or console may require fewer luminaires on a single data link path. Consult your console documentation for more information.

To connect power and data:

- Step 1. Connect data cable from console to first luminaire in chain at DATA IN connector.
- Step 2. If required, connect additional data cables from DATA THRU connectors to DATA IN connectors of remaining luminaires in link.
- Step 3. At last luminaire in link, install male termination connector at DATA THRU connector. (Luminaires and other devices on the same DMX chain may not function properly without termination.)
- Step 4. Connect AC Input Cable connector to power input source.
- Step 5. Dress AC input and data cables and secure them so that they will not interfere with luminaire head and yoke movement.

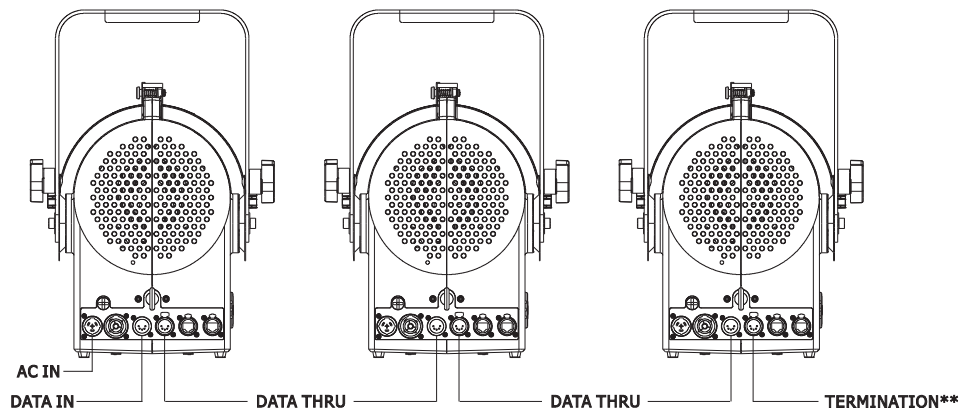

Warning! It is not recommended to power any Vari-Lite luminaire from a dimmer - even in 'NONDIM' mode. Dimmer modules are not suitable sources of power because their output modifies the AC wave form. This may work for a short time, but will eventually result in power problems, luminaire mis-operation and/or failure and may void the luminaire's warranty. Use constant current or relay modules only.

3 MENU OPERATION

CONTROL PANEL

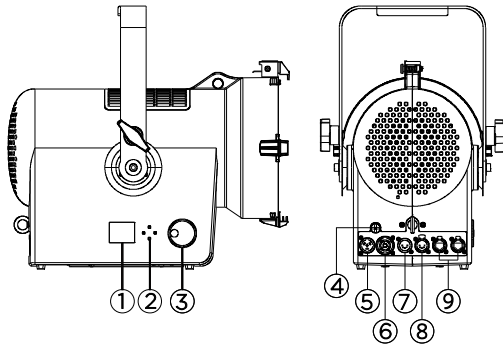

- 1 LCD display - shows menu and selected function
- 2 Buttons:
MENU - to select programming functions
DOWN - to go forward in selected functions
UP - to go backward in selected functions
ENTER - to confirm the selected function
- 3 ZOOM - manually adjust the zoom value
- 4 FUSE (T 6.3A) - protects the unit from overcurrent damage
- 5 POWER INPUT - connects to power supply
- 6 POWER THRU - connects to next fixture
- 7 DMX/RDM INPUT - 5-pin XLR cable to link the DMX console
- 8 DMX/RDM THRU - 5-pin XLR cable to link next fixture
- 9 ETHERNET - connects the fixture to an Ethernet network

Press the MENU button to select any functions, until the required function is shown in the display. Select the desired function by pressing ENTER, which will cause the display to blink. Use the UP and DOWN button to change the mode. Once the required mode has been selected, press the ENTER button to accept the selection, otherwise after a period of one minute wait, the menu will return automatically to the main functions, without any changes having been made. Return to the main functions without making any changes by pressing the MENU button.

BUTTON COMBINATION	FUNCTION
MENU + ENTER	Factory defaults
ENTER + UP	Turns the fixture on at full output
ENTER + DOWN	Toggles through Standard, Studio, and Whisper modes
UP + DOWN	Inverts display

LEVEL 1	LEVEL 2	LEVEL 3	LEVEL 4	LEVEL 5	LEVEL 6	DEFAULT	
DMX	Address	001~512					
	DMX Mode	8 - Bit					(Default)
		16 - Bit					
	Data	Ch 1 - Intensity XXX (Value)					
		Ch 2 - Intensity Fine XXX (Value)					
	All functions					
	Dmx Fail	DMX Hold					(Default)
		Blackout					
		Goto Preset	1 to 20				
		Zoom Manual (if applicable)					
	Select Signal	DMX Only					(Default)
		Art-Net	Off				(Default)
			On				
		sACN	Off				(Default)
	On						
	Set Artnet	Set Universe	0 - 15				
		Net	0 - 127				
		Sub-Net	0 - 15				
	Set sACN	Set Universe	1 - 32000				
		Priority	0 - 200				
Ethernet Settings	Ethernet IP	IP1: xxx.xxx.xxx.xxx					
		IP2: xxx.xxx.xxx.xxx					
		Manual	xxx.xxx.xxx.xxx				
	Ether Mask IP	xxx.xxx.xxx.xxx					
Settings	LED	Dimming Curve	Square Law			(Default)	
			S Curve				
			Linear				
		Output Mode	Standard			(Default)	
			Studio				
			Whisper				
			Silent				
		Color Calibration	On			(Default)	
			Off				
		Fan Mode	On				
			Auto			(Default)	
		Refresh Rate	500Hz				
			1000Hz				
			1500Hz			(Default)	
			2000Hz				
			2500Hz				
3000Hz							
3500Hz							
4000Hz							

LEVEL 1	LEVEL 2	LEVEL 3	LEVEL 4	LEVEL 5	LEVEL 6	DEFAULT
Settings Cont.	Display On Time	Auto (30 seconds since last press) On				(Default)
	Reset Defaults	Are You Sure?				
Service	Status	(No Errors... or displays a list of errors)	Give list of fixture errors			
	Diagnostics	Fan Check	Give fans speeds			
		Temp	Give LED / Fixture temperatures			
	Version	VXXX (MM/DD/YY)				
	Fixture Hours	Gives Fixture run time hours / LED hours				
	Cross load (Software)	Are You Sure?	Send			
	Password (2606)	Function Test	Red	0 - 255	0	
			Green	0 - 255	0	
			Blue	0 - 255	0	
			Lime	0 - 255	0	
			Zoom (if applicable)	0 - 255	0	
		White Balance	Red	125 - 255	255	
			Green	125 - 255	255	
			Blue	125 - 255	255	
			Lime	125 - 255	255	
Rest to Defaults		Are You Sure?				
Change Model	PLE+					
	FRESNEL+					
Playback	Power Up Preset	1 to 20				
	Preset Intensity	0 - 255			255	
	Priority	Preset				(Default)
		DMX				
	Power Up?	Preset Off				(Default)
		Preset On				
Manual Preset	Edit Settings	<i>Only uses available functions in fixture</i>				
		Intensity	0 - 255	0		
		Color Preset	0 - 255	0		
		Zoom (if applicable)	0 - 255	0		
		Red	0 - 255	0		
		Green	0 - 255	0		
		Blue	0 - 255	0		
		Lime	0 - 255	0		
		Strobe	0 - 255	0		
	Store	1 to 20	Are You Sure?	Yes/No		
	Clear	1 to 20	Are You Sure?	Yes/No		
Clear All Presets	Are You Sure?	Yes/No				



NOTE: Not all menu options are available for every fixture.

DMX MENU

Choose DMX, press the ENTER button to confirm, use the UP/DOWN button to choose from options listed.

ADDRESS

Choose Address, press the ENTER button to confirm. Use the UP/DOWN button to select range of values. Press the ENTER button to store. Press the MENU button to return to previous menu or let the unit idle one minute to exit.

DMX MODE

Choose DMX Mode, press the ENTER button to confirm. Use the UP/DOWN button to select mode. Press the ENTER button to store. Press the MENU button to return to previous menu or let the unit idle one minute to exit.

DATA

Choose Data, press the ENTER button to confirm. Use the UP/DOWN button to select option. Choose Ch1 – Intensity xxx(value), Ch2 – Intensity Fine xxx(Value), ... All functions, press the ENTER button to store. Press the MENU button to return to previous menu or let the unit idle one minute to exit menu mode.

DMX FAIL

To select DMX Fail, press the ENTER button to confirm. Use the UP/DOWN button to select DMX Hold or Blackout, press the ENTER button to store. Press the MENU button back to the last menu or let the unit idle one minute to exit menu mode.

SELECT SIGNAL

To select Select Signal, press the ENTER button to confirm. Use the UP/DOWN button to select DMX Only, Art-Net or sACN, press the ENTER button to store. Press the MENU button back to the last menu or let the unit idle 30 seconds to exit menu mode.

SELECT ARTNET

To select Set Artnet, press the ENTER button to confirm. Use the UP/DOWN button to select Set Universe, Net or Sub-Net, press the ENTER button to store. Press the MENU button back to the last menu or let the unit idle 30 seconds to exit menu mode.

SELECT sACN

To select Set sACN, press the ENTER button to confirm. Use the UP/DOWN button to select Set Universe or Priority, press the ENTER button to store. Press the MENU button back to the last menu or let the unit idle 30 seconds to exit menu mode.

ETHERNET SETTINGS

To select Ethernet Settings, press the ENTER button to confirm. Use the UP/DOWN button to select Ethernet IP or Ether Mask IP, press the ENTER button to store. Press the MENU button back to the last menu or let the unit idle 30 seconds to exit menu mode.

SETTINGS MENU

Choose Settings, press the ENTER button to confirm, use the UP/DOWN button to choose from options shown on screen.

LED

Choose LED, press the ENTER button to confirm. Use the UP/DOWN button to select an option. Press the ENTER button to store. Press the MENU button to return to previous menu or let the unit idle one minute to exit menu mode.

DIMMING CURVE

To Choose Dimming Curve, press the ENTER button to confirm. Use the UP/DOWN button to Choose Square Law Curve, S Law Curve or Linear Law Curve, press the ENTER button to store. Press the MENU button to return to previous menu or let the unit idle one minute to exit menu mode.

OUTPUT MODE

Choose Output Mode, press the ENTER button to confirm. Use the UP/DOWN button to select Standard, Studio, or Whisper. Press the MENU button to return to previous menu.

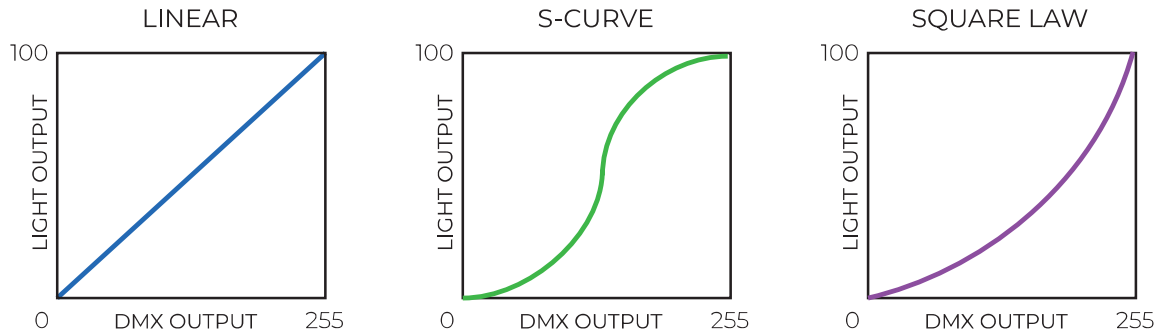

COLOR CALIBRATION

Choose Color Cal, press the ENTER button to confirm. Use the UP/DOWN button to Choose ON or OFF. Press the MENU button to return to previous menu.

FAN MODE

Select Fan Mode, press the ENTER button to confirm. Use the UP/DOWN button to select On or Auto, press the ENTER button to store. Press the MENU button back to the last menu or let the unit idle one minute to exit menu mode.

REFRESH RATE

Select Refresh Rate, press the ENTER button to confirm. Use the UP/DOWN button to select 500Hz, 1000Hz, 1500Hz, 2000Hz, 2500Hz, 3000Hz, 3500Hz, 4000Hz, press the ENTER button to store. Press the MENU button back to the last menu or let the unit idle one minute to exit menu mode.

DISPLAY ON TIME

To select Display On Time, press the ENTER button to confirm. Use the UP/DOWN button to select Auto(30 seconds since last press) or On, press the ENTER button to store. Press the MENU button back to the last menu or let the unit idle one minute to exit menu mode.

RESET DEFAULTS

To select Reset Defaults, press the ENTER button to confirm, Are You Sure? will show on the display, press the ENTER button to store. Press the MENU button back to the last menu or let the unit idle one minute to exit menu mode.

SERVICE

SERVICE MENU

To select Service, press the ENTER button to confirm, use the UP/DOWN button to select Status, Diagnostics, Version, Fixture Hours, Crossload(Software) and Password(2606).

STATUS

To select Status, press the ENTER button to confirm, No Errors or a list of errors will show on the display, press the MENU button back to exit.

DIAGNOSTICS

To select Diagnostics, press the ENTER button to confirm. Use the UP/DOWN button to select Fan Check or Temp, press the ENTER button to store. Press the MENU button back to the last menu or let the unit idle one minute to exit menu mode.

VERSION

To select Version, press the ENTER button to confirm, Version will show on the display, press the MENU button back to exit.

FIXTURE HOURS

To select Fixture Hours, press the ENTER button to confirm, Fixture Hours will show on the display, press the MENU button back to exit.

CROSSLOAD(SOFTWARE)

Select Crossload(Software), press the ENTER button to confirm, Are You Sure? will show on the display, press the ENTER button to store. Press the MENU button back to the last menu or let the unit idle one minute to exit menu mode.



NOTE: Incoming DMX must be removed from the fixture or software crossload will not be activated.

PASSWORD

Select Password(2606), press the ENTER button to confirm. Use the UP/DOWN button to select White Balance or Change Mode, press the ENTER button to store. Press the MENU button back to the last menu or let the unit idle one minute to exit menu mode.

FUNCTION TEST

To select Function Test, press the ENTER button to confirm. Use the UP/DOWN button to select Red, Green, Blue, Lime or Zoom (if applicable), press the ENTER button to store. Press the MENU button back to the last menu or let the unit idle 30 seconds to exit menu mode.

WHITE BALANCE

To select White Balance, press the ENTER button to confirm. Use the UP/DOWN button to select Red, Green, Blue, Lime or Reset to Defaults (Reset to White Balance), press the ENTER button to store. Press the MENU button back to the last menu or let the unit idle one minute to exit menu mode.

CHANGE MODE

To select Change Mode, press the ENTER button to confirm. Use the UP/DOWN button to select PLE+ or FRESNEL+, press the ENTER button to store. Press the MENU button back to the last menu or let the unit idle one minute to exit menu mode.

MANUAL PRESET MENU

PLAYBACK

To select Change Mode, press the ENTER button to confirm. Use the UP/DOWN button to select PLE+ or FRESNEL+, press the ENTER button to store. Press the MENU button back to the last menu or let the unit idle one minute to exit menu mode.

POWER UP PRESET

To select Change Mode, press the ENTER button to confirm. Use the UP/DOWN button to select PLE+ or To select Power Up Pre-set, press the ENTER button to confirm. Use the UP/DOWN button to select from 1 to 20, press the ENTER button to store. Press the MENU button back to the last menu or let the unit idle 30 seconds to exit menu mode.

PRESET INTENSITY

To select Preset Intensity, press the ENTER button to confirm. Use the UP/DOWN button to select from 0 to 255, press the ENTER button to store. Press the MENU button back to the last menu or let the unit idle 30 seconds to exit menu mode.

PRIORITY

To select Priority, press the ENTER button to confirm. Use the UP/DOWN button to select Preset or DMX, press the ENTER button to store. Press the MENU button back to the last menu or let the unit idle 30 seconds to exit menu mode.

POWER UP?

Power Up? — To select Power Up?, press the ENTER button to confirm. Use the UP/DOWN button to select Preset Off or Preset On, press the ENTER button to store. Press the MENU button back to the last menu or let the unit idle 30 seconds to exit menu mode.

EDIT

To select Edit, press the ENTER button to confirm. Use the UP/DOWN button to select Load Preset, Edit Settings, Store, Clear or Clear All Presets. Press the ENTER button to store. Press the MENU button back to the last menu or let the unit idle 30 seconds to exit menu mode.

LOAD PRESET

To select Load Preset, press the ENTER button to confirm. Use the UP/DOWN button to select from 1 to 20, press the ENTER button to store. Press the MENU button back to the last menu or let the unit idle 30 seconds to exit menu mode.

EDIT SETTINGS

To select Edit Settings, press the ENTER button to confirm. Use the UP/DOWN button to select Intensity, Color Preset, Zoom (if applicable), Red, Green, Blue, Lime or Strobe, press the ENTER button to store. Press the MENU button back to the last menu or let the unit idle 30 seconds to exit menu mode.

STORE

To select Store, press the ENTER button to confirm. Use the UP/DOWN button to select from 1 to 20, press the ENTER button to store. Press the MENU button back to the last menu or let the unit idle 30 seconds to exit menu mode.

CLEAR

To select Clear, press the ENTER button to confirm. Use the UP/DOWN button to select from 1 to 20, press the ENTER button to store. Press the MENU button back to the last menu or let the unit idle 30 seconds to exit menu mode.

CLEAR ALL PRESETS

To select Clear All Presets, press the ENTER button to confirm. Are You Sure? will show on the display, press the ENTER button to store, press the ENTER button to store. Press the MENU button back to the last menu or let the unit idle 30 seconds to exit menu mode.

TABLE 2. 16-BIT MODE

DMX CHANNEL	PARAMETER	DEFAULTS	RANGE DMX	DESCRIPTION
4	Color Preset continued	0	44 - 47	CP - 11 - Moroccan Pink
			48 - 51	CP - 12 - Pink
			52 - 55	CP - 13 - Flesh Pink
			56 - 59	CP - 14 - Bright Rose
			60 - 63	CP - 15 - Follies Pink
			64 - 67	CP - 16 - Fuchsia Pink
			68 - 71	CP - 17 - Surprise Pink
			72 - 75	CP - 18 - Congo Blue
			76 - 79	CP - 19 - Blue
			80 - 83	CP - 20 - Virgin Blue
			84 - 87	CP - 21 - Midnight Maya
			88 - 91	CP - 22 - Double C.T. Blue
			92 - 95	CP - 23 - Slate Blue
			96 - 99	CP - 24 - Regal Blue
			100 - 103	CP - 25 - Full C.T. Blue
			104 - 107	CP - 26 - Steel Blue
			108 - 111	CP - 27 - Lighter Blue
			112 - 115	CP - 28 - Cyan
			116 - 119	CP - 29 - Marine Blue
			120 - 123	CP - 30 - Soft Green
			124 - 127	CP - 31 - Moss Green
			128 - 131	CP - 32 - Green
			132 - 135	CP - 33 - Fern Green
			136 - 139	CP - 34 - JAS Green
			140 - 143	CP - 35 - Pale Green
			144 - 147	CP - 36 - Spring Yellow
			148 - 151	CP - 37 - Yellow
			152 - 155	CP - 38 - Deep Amber
156 - 159	CP - 39 - Chrome Orange			
160 - 163	CP - 40 - Orange			
164 - 167	CP - 41 - Magenta			
168 - 171	CP - 42 - Flame Red			
172 - 175	CP - 43 - Purple			
176 - 255	Reserved for future use.			
5	Zoom	127	0 - 255	Narrow >>>> Wide mechanical movement of zoom
6	Fixture Control	0	0	Idle (Default)
			6 - 10	Standard Mode (Default Mode)
			11 - 15	Studio Mode
			16 - 20	Whisper Mode
			21 - 25	Silent Mode (Fans off)
			26 - 255	Reserved

TABLE 2. 16-BIT MODE

DMX CHANNEL	PARAMETER	DEFAULTS	RANGE DMX	DESCRIPTION
7	Red (16-bit high)	65535	0 - 65535	Red LED output level
8	Red (16-bit low)			
9	Green (16-bit high)	65535	0 - 65535	Green LED output level
10	Green (16-bit low)			
11	Blue (16-bit high)	65535	0 - 65535	Blue LED output level
12	Blue (16-bit low)			
13	Lime (16-bit high)	65535	0 - 65535	Lime LED output level
14	Lime (16-bit low)			

5 RDM PARAMETER IDS

Remote Device Management (RDM) is a protocol enhancement to USITT DMX512 that allows bi-directional communication between a lighting or system controller and attached RDM compliant devices over a standard DMX line. This protocol will allow configuration, status monitoring, and management of these devices in such a way that does not disturb the normal operation of standard DMX512 devices that do not recognize the RDM protocol.

ACCLAIM LED FRESNEL RDM PRODUCT PARAMETER IDS				
Model ID	Manufacturer	Vendor ID	Model Description	Product Category
0x0240	Vari-Lite	0x564C	VL600 Acclaim Fresnel+	0x0101

The table on the following pages outlines and describes all the RDM parameters IDs associated with the VL600 Acclaim Fresnel+.

GET ALLOWED	SET ALLOWED	RDM PARAMETER IDS	VALUE	COMMENT	ESTA STANDARD	REQUIRED / IMPLEMENTED	DMX / UI DESCRIPTION
Category - Network Management							
		DISC_UNIQUE_BRANCH	0x0001		X	X	
		DISC_MUTE	0x0002		X	X	
		DISC_UN_MUTE	0x0003		X	X	
X		PROXIED_DEVICES	0x0010				
X		PROXIED_DEVICES_COUNT	0x0011				
X	X	COMMS_STATUS	0x0015				
Category - Status Collection							
X		QUEUED_MESSAGE	0x0020				
X		STATUS_MESSAGES	0x0030			X	Status
X		STATUS_ID_DESCRIPTION	0x0031			X	
	X	CLEAR_STATUS_ID	0x0032				
X	X	SUB_DEVICE_STATUS_REPORT_THRESHOLD	0x0033				
Category - RDM Information							
X		SUPPORTED_PARAMETERS	0x0050		X	X	
X		PARAMETER_DESCRIPTION	0x0051		X	X	
Category - Product Information							
X		DEVICE_INFO	0x0060		X	X	
X		PRODUCT_DETAIL_ID_LIST	0x0070				
X		DEVICE_MODEL_DESCRIPTION	0x0080			X	
X		MANUFACTURER_LABEL	0x0081			X	
X	X	DEVICE_LABEL	0x0082			X	
X	X	FACTORY_DEFAULTS	0x0090			X	Reset Defaults
X		LANGUAGE_CAPABILITIES	0x00A0				
X	X	LANGUAGE	0x00B0				
X		SOFTWARE_VERSION_LABEL	0x00C0		X	X	Version
X		BOOT_SOFTWARE_VERSION_ID	0x00C1				
X		BOOT_SOFTWARE_VERSION_LABEL	0x00C2				
Category - DMX512 Setup							
X	X	DMX_PERSONALITY	0x00E0			X	DMX Mode
X		DMX_PERSONALITY_DESCRIPTION	0x00E1			X	
X	X	DMX_START_ADDRESS	0x00F0		X	X	Address
X		SLOT_INFO	0x0120			X	
X		SLOT_DESCRIPTION	0x0121			X	
X		DEFAULT_SLOT_VALUE	0x0122			X	
Category – Sensors 0x02xx USE							
X		SENSOR_DEFINITION	0x0200			X	

GET ALLOWED	SET ALLOWED	RDM PARAMETER IDS	VALUE	COMMENT	ESTA STANDARD	REQUIRED / IMPLEMENTED	DMX / UI DESCRIPTION
X	X	SENSOR_VALUE	0x0201	Fan Speed and Temperatures		X	Diagnostics
	X	RECORD_SENSORS	0x0202				
Category - Dimmer Settings 0x03xx - FUTURE USE							
X	X	Dimmer Curve	0x0343			X	
X		Dimmer Curve Description	0x0344			X	
X	X	Modulation Frequency	0x0347			X	
X		Modulation Frequency Description	0x0348			X	
Category - Power / Lamp Settings 0x04xx							
X	X	DEVICE_HOURS	0x0400			X	Fixture Hours
X	X	LAMP_HOURS	0x0401				
X	X	LAMP_STRIKES	0x0402				
X	X	LAMP_STATE	0x0403				
X	X	LAMP_ON_MODE	0x0404				
X	X	DEVICE_POWER_CYCLES	0x0405				
Category - Display Settings 0x05xx							
X	X	DISPLAY_INVERT	0x0500				
X	X	DISPLAY_LEVEL	0x0501				
Category - Configuration 0x06xx							
X	X	PAN_INVERT	0x0600				
X	X	TILT_INVERT	0x0601				
X	X	PAN_TILT_SWAP	0x0602				
X	X	REAL_TIME_CLOCK	0x0603				
Category - Control 0x10xx							
X	X	IDENTIFY_DEVICE	0x1000		X	X	
	X	RESET_DEVICE	0x1001			X	
X	X	POWER_STATE	0x1010				
X	X	PERFORM_SELFTEST	0x1020	All Test, Pan/Tilt, Encoder			
X		SELF_TEST_DESCRIPTION	0x1021				
	X	CAPTURE PRESET	0x1030	See E1-20_2010a			
X	X	PRESET PLAYBACK	0x1031	Table A-7 defines			
		ESTA Reserved Future RDM	0x7FE0-0x7FFF				
		Manufacturer-Specific PIDs	0x8000-0xFFDF				
X	X	Output Power Mode	0x8A97	Value range depends on options (Standard, Studio, etc)		X	LED Output Mode
X	X	Pan/Tilt Feedback (On/Off)	0x8AD3				

GET ALLOWED	SET ALLOWED	RDM PARAMETER IDS	VALUE	COMMENT	ESTA STANDARD	REQUIRED / IMPLEMENTED	DMX / UI DESCRIPTION
X	X	Display On Time	0x8AA0	Value range depends on options		X	Display On Time
X	X	LED Dimmer Curve	0x8AA1	Value range depends on options			LED Dimming Curve
X	X	Pan Tilt Movement (On/Off)	0x8AA2				
X	X	Head Motor Movement (On/Off)	0x8AA3				
X	X	Auto Shutdown Mode	0x8AA4	Value range depends on options			
X	X	LED Hours	0x8AA5				
X	X	Dim Snap (On/Off)	0x8AA6				
X	X	Color Snap (On/Off)	0x8AA7				
X	X	Auto Fan Mode (On/Off)	0x8AA8				LED Fan Mode
X	X	Gamma Shift	0x8AA9	Value range depends on options			
X	X	Tungsten Dimming (On/Off)	0x8AAA				
X	X	CTB Correction (On/Off)	0x8AAB				
X	X	LED Refresh Rate	0x8AAC	Value range depends on options			LED Refresh Rate
X	X	Side Hang (On/Off)	0x8AAD				
X	X	Focus Track (On/Off)	0x8AAE				
	X	Control Signal select DMX only/ArtNET (On/Off)	0x8AAF				
	X	Recalibrate Fixture (Level)	0x8AB0	different levels (all, position, color, etc)			
X	X	DMX Fail (Hold, Blackout, GOTO Preset)	0x8AB1				DMX Fail
X	X	ArtNet Universe	0x8AB2				
X	X	ArtNet Net	0x8AB3				
X	X	ArtNet Sub-Net	0x8AB4				
X	X	ArtNet Ethernet IP	0x8AB5				
X	X	ArtNet Ethernet Sub-Net Mask	0x8AB6				
X	X	Manual PRESET Playback Power Up Preset	0x8AB7				
X	X	Manual PRESET Playback Preset Intensity	0x8AB8				
X	X	Manual PRESET Playback Priority	0x8AB9				
X	X	Manual PRESET Playback Power Up?	0x8ABA				
X	X	LED Color Calibration (On/Off)	0x8ABB			X	LED Color Calibration

APPENDIX A

CARE AND MAINTENANCE

TROUBLESHOOTING

Luminaire does not work; light and fan do not turn on.

- Check power connection and main fuse.
- Measure the mains voltage on the main connector.

Not responding to DMX controller.

- If DMX LED is not illuminated, verify that the DMX cables are properly connected.
- If the DMX LED is illuminated and there is no response, verify DMX address settings and the DMX polarity.
- If you experience intermittent DMX signal problems, check the pins on the connectors or on the PCB.
- Test with a different DMX controller.
- Check if the DMX cables run near or alongside high voltage cables that may cause interference to the DMX interface circuit.

CLEANING

Cleaning the inside of the luminaire must be carried out periodically in order to optimize the light output. Cleaning frequency depends on the environment in which the fixture operates. Damp, smoky or particularly dusty surroundings can cause greater accumulation of dirt on the fixture's optics.

- Clean with a soft cloth using glass cleaning fluid.
- Dry parts carefully.
- Clean the external optics at least every 30 days.

APPENDIX B FAN SPEED AND CONTROL

FAN SPEED AND CONTROL

All Vari-lite luminaires will be governed by the same Fan speed v Noise levels v Maximum power output rules as details below. These noises related to these levels will confirm to Noise Criteria levels details of which are contained within the document.

There are 3 control parameters can be selected separately or in conjunction when permitted to manage Fan speed v Noise levels v Maximum power output.

NOTE: Not all fixture have all modes or functions refer to DMX map and User interface menu tree to see if you product has one of more of these functions.

tem 1- Fan 'v' Output Preset Modes

These modes are selectable at either / or the fixtures DMX control channel or via the fixture user interface screen. The section of the modes works in conjunction with Items 3 and will also active or deactivate the Item 2.

Boost mode – LED output boosted to >120% of standard output fan speeds increased manage heat level of LED (may be limited to only run for XXhrs). Fixture will not exceed NC45 – NC55 sound levels in this mode

Standard mode - Full LED Output + Fan Spin at top speed (loudest setting). Fixture will not exceed NC40 sound levels in this mode

Studio Mode - Fan speed reduced to appropriate amount to reduce dB levels >10% of full speed + LED @ max output approximately 80% of Standard output at appropriate level to ensure LED work at optimum temperature and output efficiency (fan speed remains at a constant speed and do not ramp up or down) NC35

Whisper mode - Fan speed reduced to appropriate amount to reduce dB levels to >30% of the full speed + LED Max output approximately 60% of Standard output at appropriate level to ensure LED work at optimum temperature and output efficiency (Fan speed remains at a constant speed and do not ramp up or down) NC25

Silent Mode – ideally Fans do not spin + output capped at appropriate level to ensure LED work at optimum temperature and output efficiency (Fan should never switch on in this mode or change speed if they on) NC15 target level.

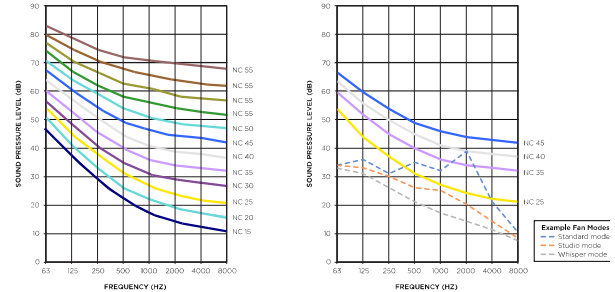

MODE	LED OUTPUT	FAN SPEED	NOISE CRITERION	EQUIVALENT SOUND LEVEL DBA (@3M)
Boost Mode	>100%	Boosted fan speed constant	NC45	50
Standard Mode	Full 100%	Full 100% constant	NC40	45
Studio Mode	80%	Appropriate speed to reduce dB levels >10% of full speed	NC35	40
Whisper Mode	60%	Appropriate speed to reduce dB levels >30% of full speed	NC25	35
Silent Mode	TBC	Fan off	NC15	25

NOISE CRITERION	OCTAVE BAND CENTER FREQUENCY (HZ)							
	63	125	250	500	1000	2000	4000	8000
	SOUND PRESSURE LEVELS (DB)							
NC-15	47	36	29	22	17	14	12	11
NC-20	51	40	33	26	22	19	17	16
NC-25	54	44	37	31	27	24	22	21
NC-30	57	48	41	35	31	29	28	27
NC-35	60	52	45	40	36	34	33	32
NC-40	64	56	50	45	41	39	38	37
NC-45	67	60	54	49	46	44	43	42
NC-50	71	64	58	54	51	49	48	47
NC-55	74	67	62	58	56	54	53	52
NC-60	77	71	67	63	61	59	58	57
NC-65	80	75	71	68	66	64	63	62
NC-70	83	79	75	72	71	70	69	68

TECHNICAL SUPPORT

GLOBAL 24HR TECHNICAL SUPPORT:

Call: +1 214 647 7880

entertainment.service@signify.com

NORTH AMERICA SUPPORT:

Call: 877-VARI-LITE (877-827-4583)

entertainment.service@signify.com

EUROPEAN CUSTOMER SERVICE:

entertainment.europe@signify.com

©2025 Signify Holding. All rights reserved.

All trademarks are owned by Signify Holding or their respective owners. The information provided herein is subject to change, without notice. Signify does not give any representation or warranty as to the accuracy or completeness of the information included herein and shall not be liable for any action in reliance thereon. The information presented in this document is not intended as any commercial offer and does not form part of any quotation or contract, unless otherwise agreed by Signify. Data subject to change.